

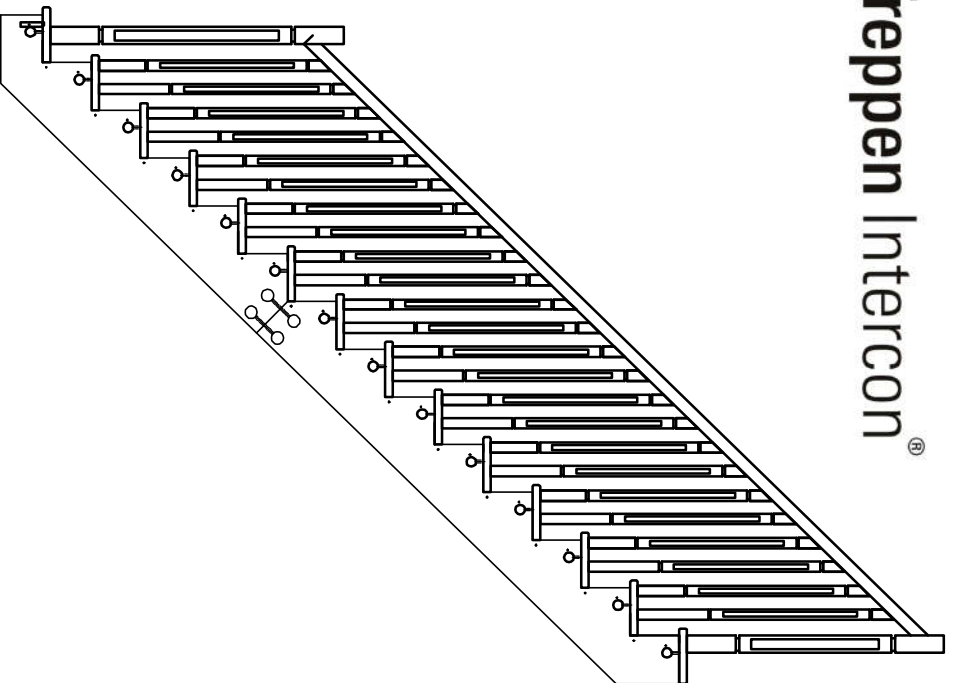

Treppen Intercon®

A



Treppen Intercon®

B

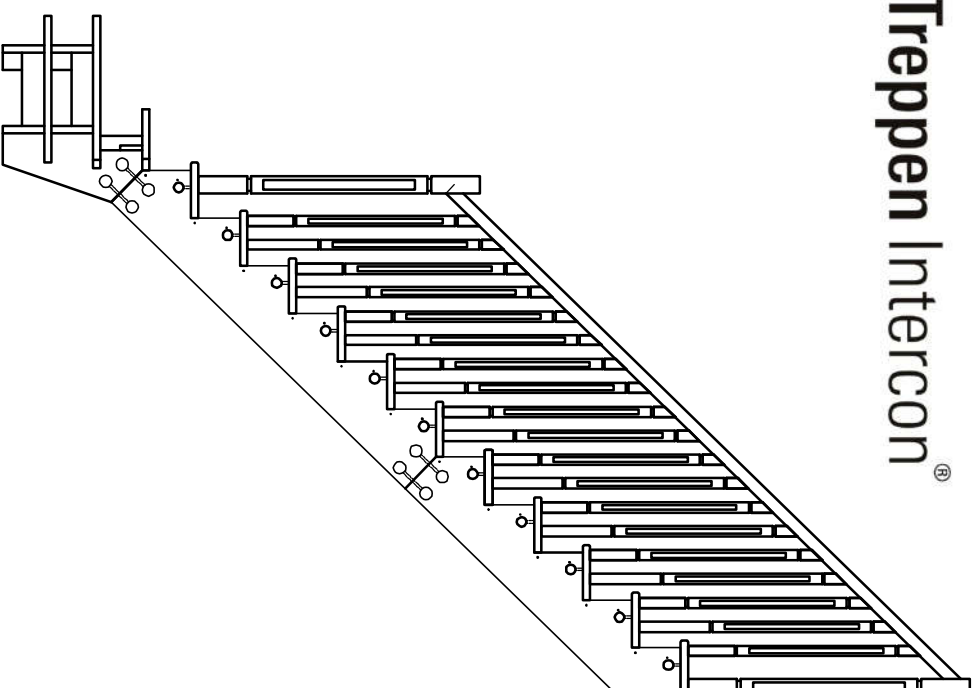

NIZZA

800 STRAIGHT / WINDER STAIR





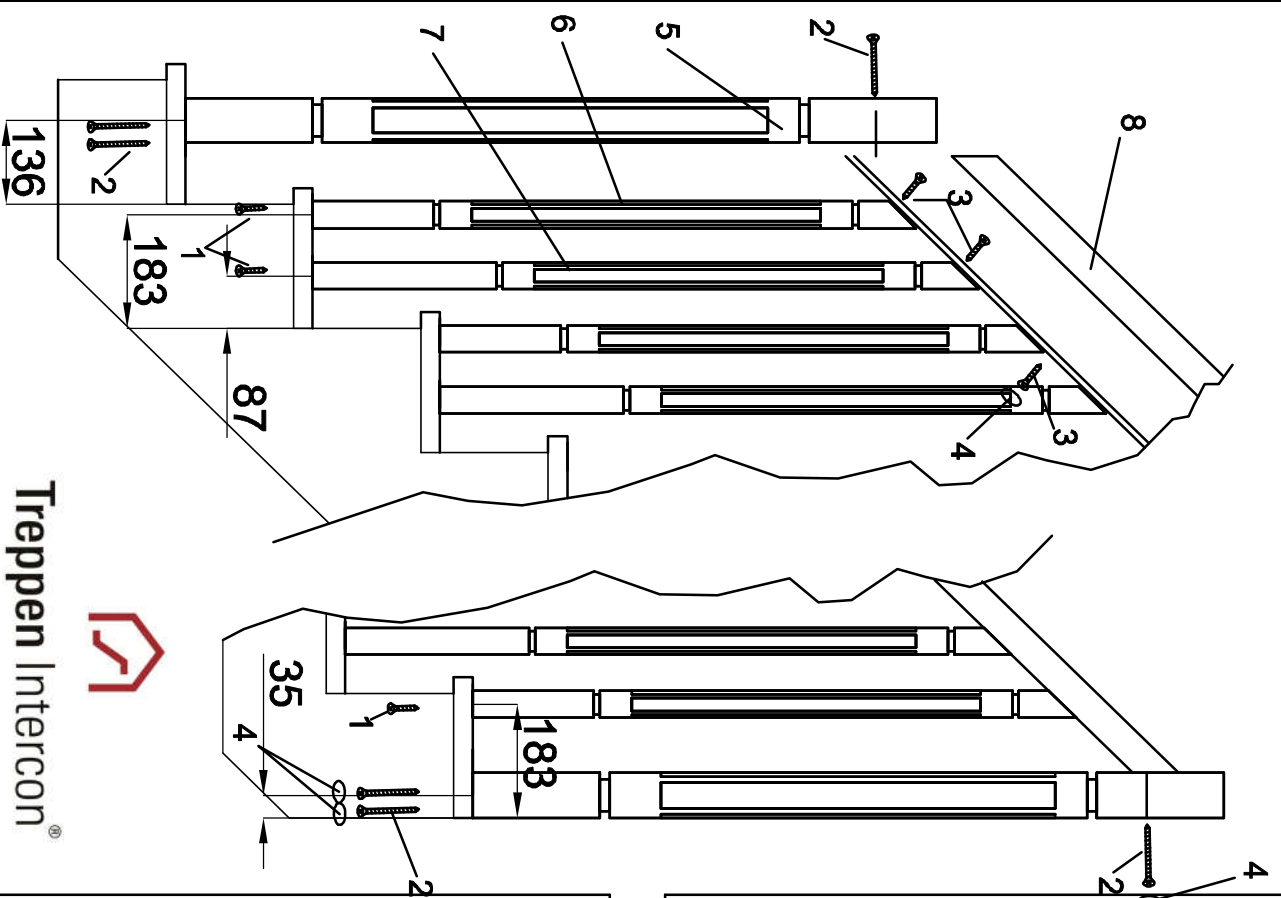

RAILING WITH SQUARE BALUSTERS

1/2

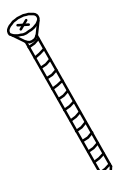





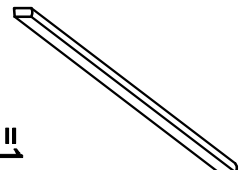

Treppen Intercon®

A

1		=25	2		=6	3		=29	4		=35
5		=2	6		=13	7		=12	8		=1

B

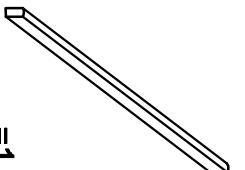
1		=21	2		=6	3		=25	4		=31
5		=2	6		=10	7		=9	8		=1

NIZZA

800 STRAIGHT / WINDER STAIR

RAILING WITH SQUARE BALUSTERS

2/2





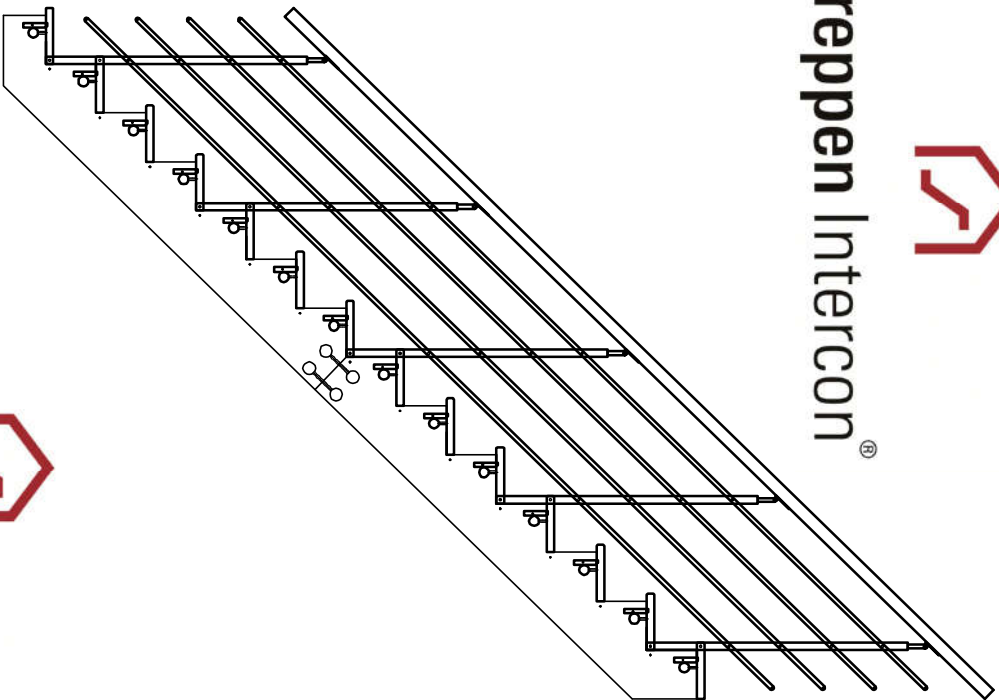

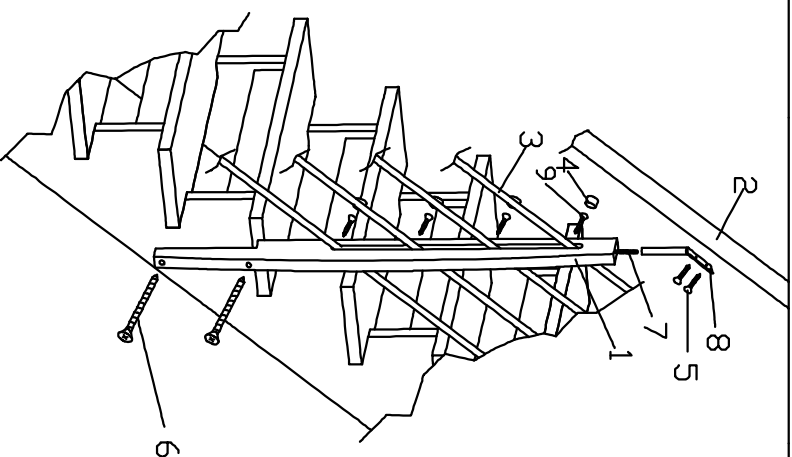

Treppen Intercon®

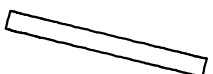
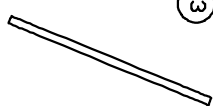

Treppen Intercon®



<p>①</p>  <p>=5</p>	<p>②</p>  <p>=1</p>	<p>③</p>  <p>=4</p>	<p>④</p>  <p>=20</p>
<p>⑤</p>  <p>3,5x25 =10</p>	<p>⑥</p>  <p>6x90 =10</p>	<p>⑦</p>  <p>M6x60 =5</p>	<p>⑧</p>  <p>=5</p> <p>⑨</p>  <p>4x40 =20</p>





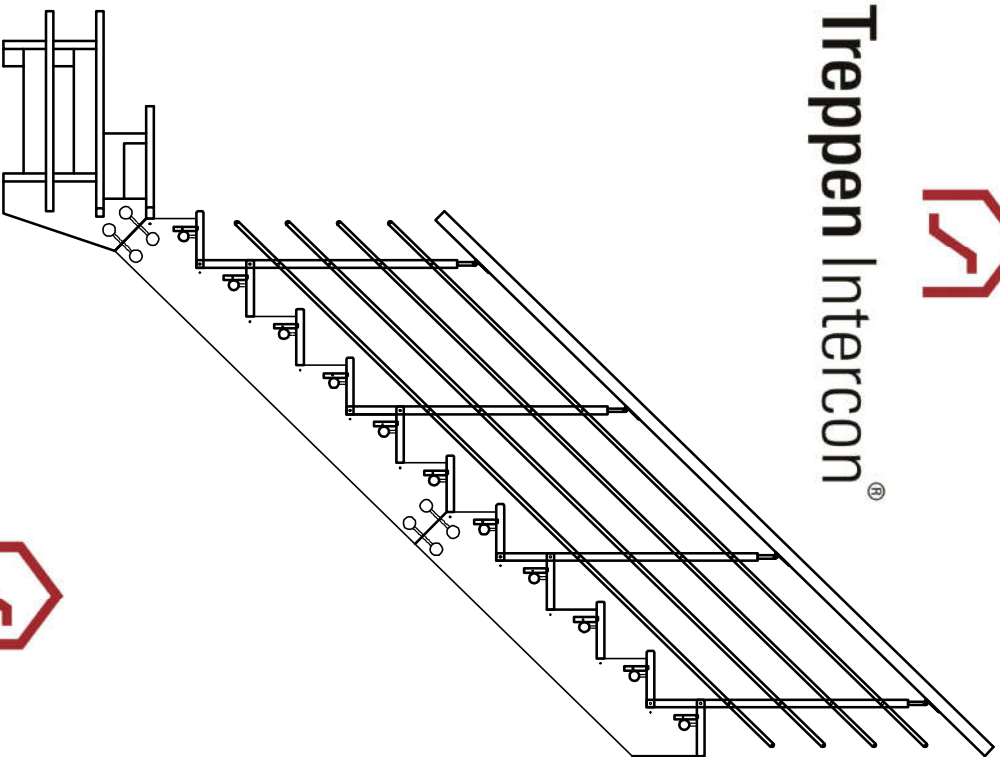

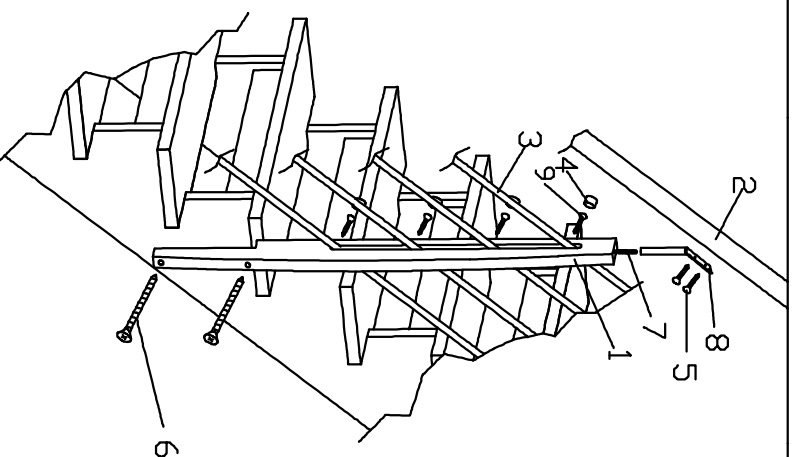

Treppen Intercon®

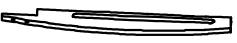
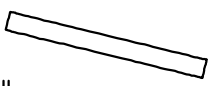
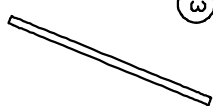

Treppen Intercon®



<p>①</p>  <p>=4</p>	<p>②</p>  <p>=1</p>	<p>③</p>  <p>=4</p>	<p>④</p>  <p>=16</p>
<p>⑤</p>  <p>3,5x25 =8</p>	<p>⑥</p>  <p>6x90 =8</p>	<p>⑦</p>  <p>M6x60 =4</p>	<p>⑧</p>  <p>=4</p>
			<p>⑨</p>  <p>4x40 =16</p>



Treppen Intercon®

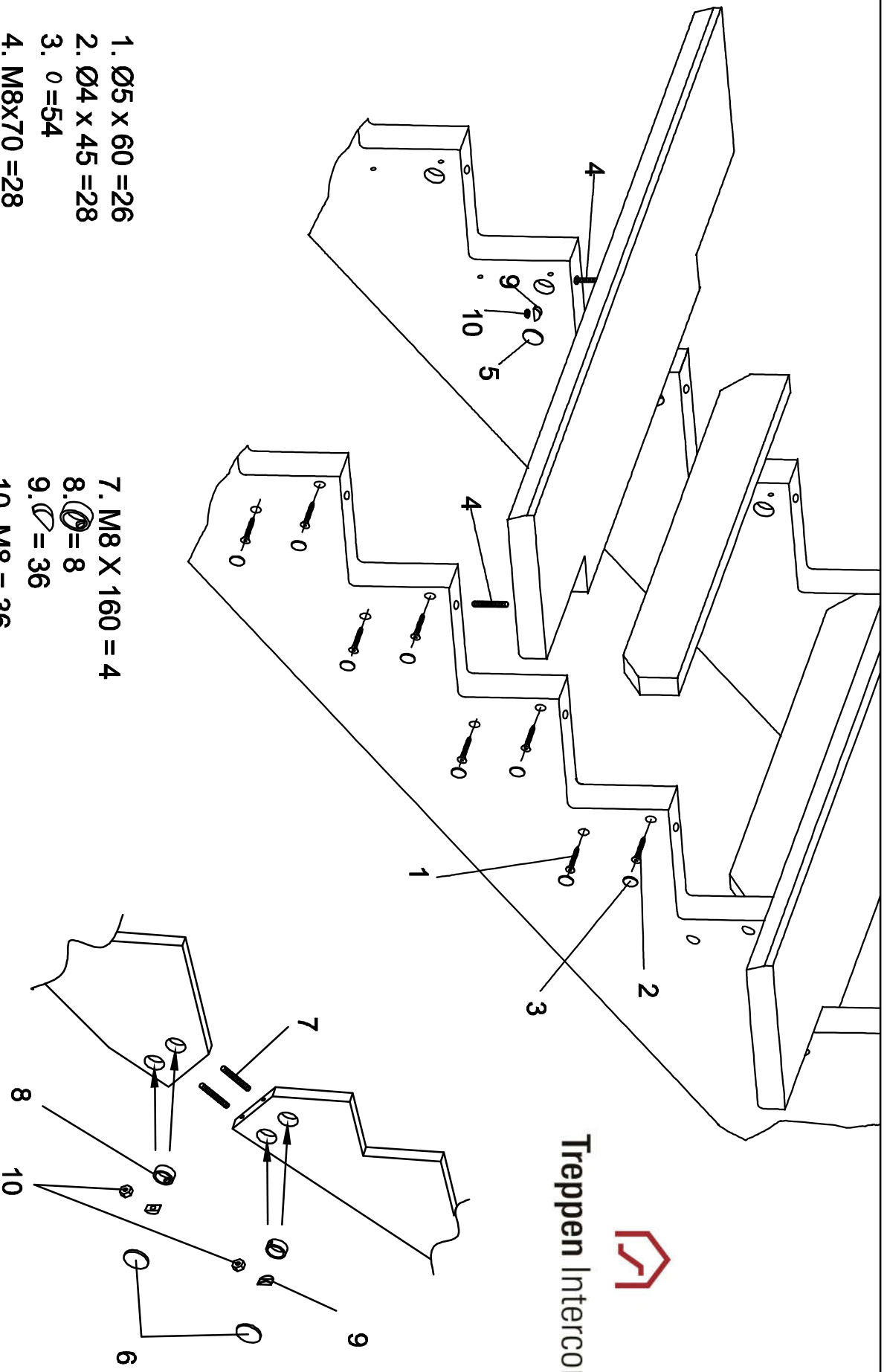

- 1. Ø5 x 60 = 26
- 2. Ø4 x 45 = 28
- 3. Ø = 54
- 4. M8x70 = 28
- 5. Ø40 = 28
- 6. Ø50 = 8

- 7. M8 X 160 = 4
- 8. Ø = 8
- 9. Ø = 36
- 10. M8 = 36

NIZZA 800 STRAIGHT STAIRCASE

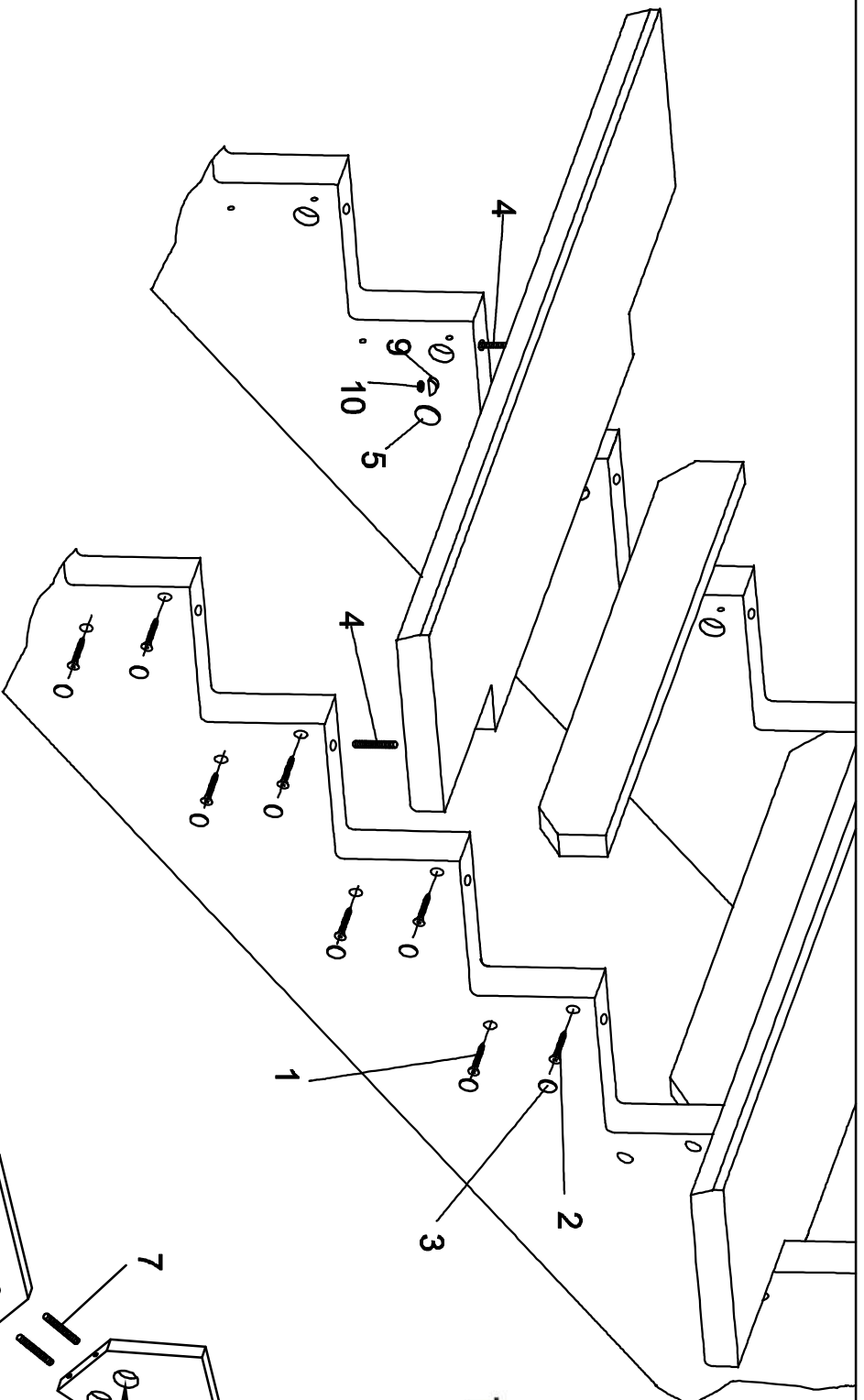

Treppen Intercon®

- 1. Ø5 x 60 =22
- 2. Ø4 x 45 =22
- 3. Ø40 =48
- 4. M8x70 =22
- 5. Ø40 =22
- 6. Ø50 =8

- 7. M8 X 160 = 4
- 8. Ø8 = 8
- 9. Ø48 = 30
- 10. M8 = 30

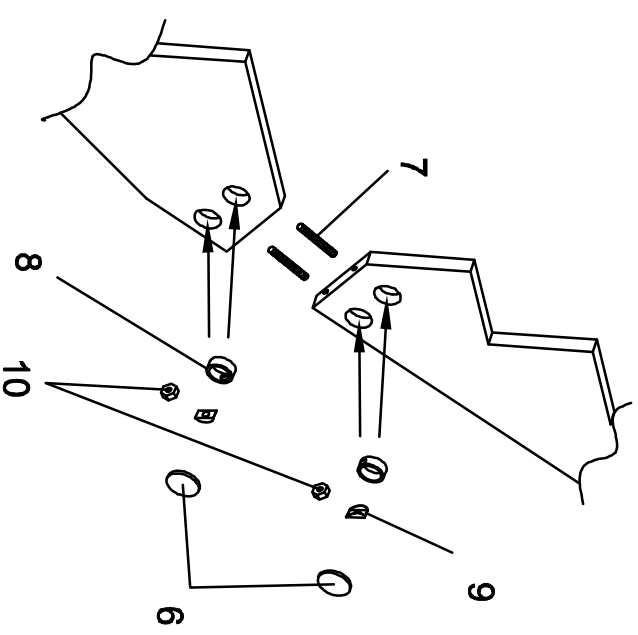



NIZZA 800 STAIRCASE WITH WINDER

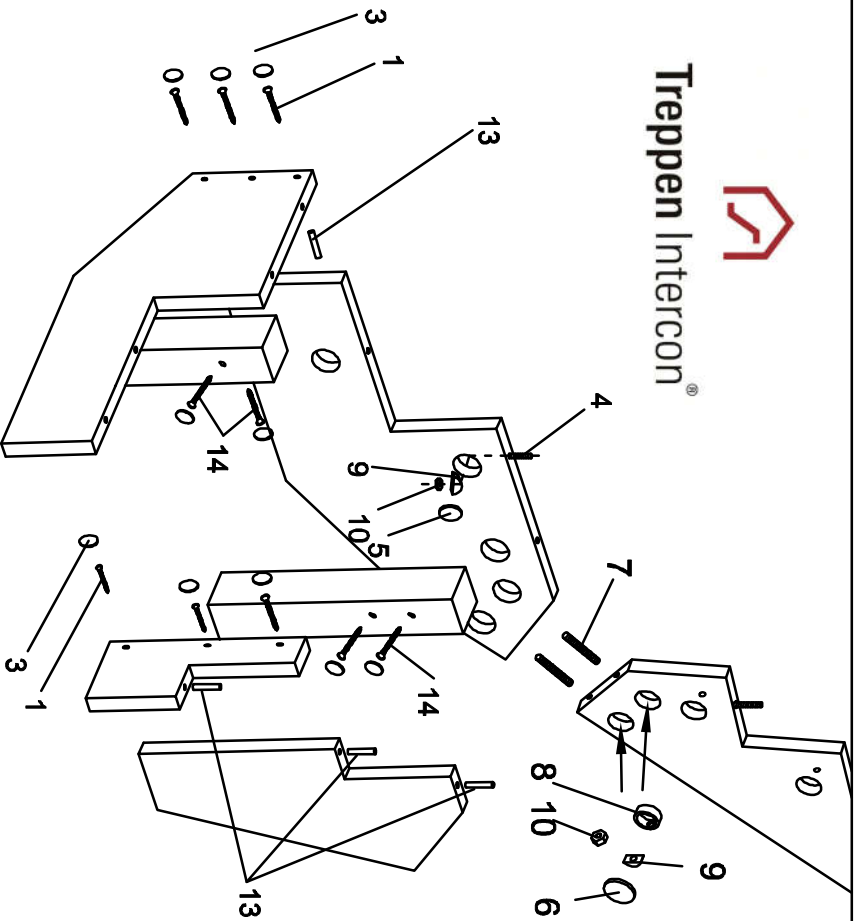

Treppen Intercon®



- 1. Ø5 x 60 = 6
- 2. Ø4 x 45 = 2
- 3. 0 = 12
- 4. M8x70 = 7
- 5. Ø40 = 7
- 6. Ø50 = 8
- 7. M8 X 160 = 4
- 8.  = 8

- 9.  = 15
- 10. M8 = 15
- 11. Ø4 x 25 = 10
- 12. = 2
- 13.  = 5
- 14. Ø6 x 90 = 4

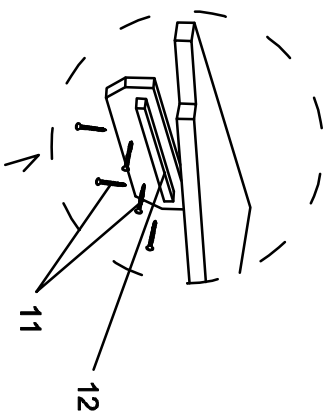

Treppen Intercon®

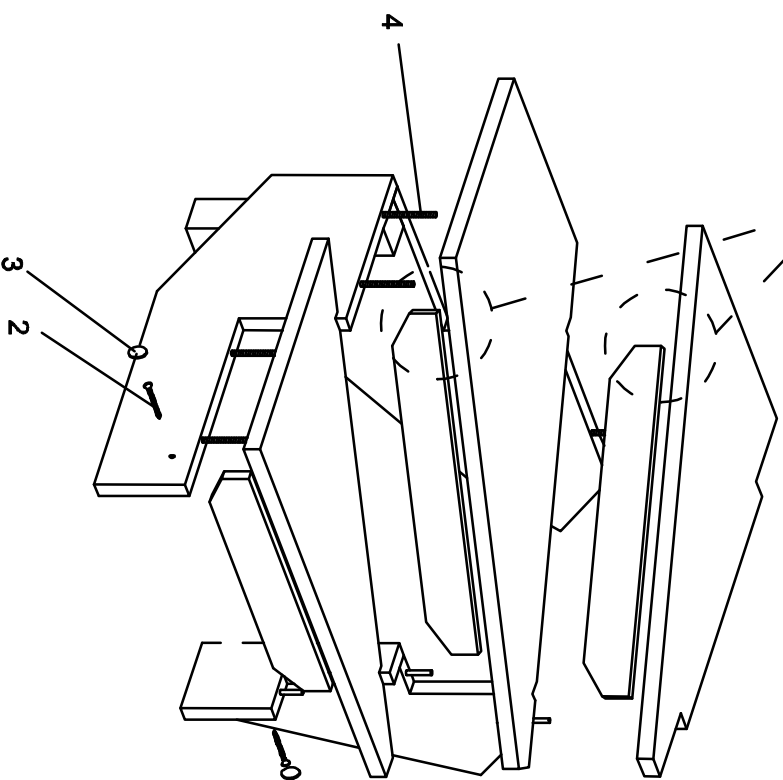

- 2
- 3
- 4

NIZZA 800 WINDER

1/1

