

	9	10	11	12	13
H min	1980mm	2200mm	2420mm	2640mm	2860mm
H max	2142mm	2380mm </td <td>2618mm</td> <td>2856mm</td> <td>3094mm</td>	2618mm	2856mm	3094mm
DM120	232°	258°	284°	310°	336°
DM140	236°	262°	288°	314°	340°
DM160	205°	228°	251°	273°	296°

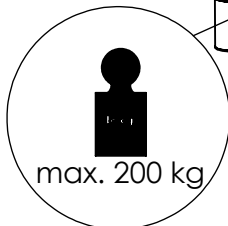

DM T20

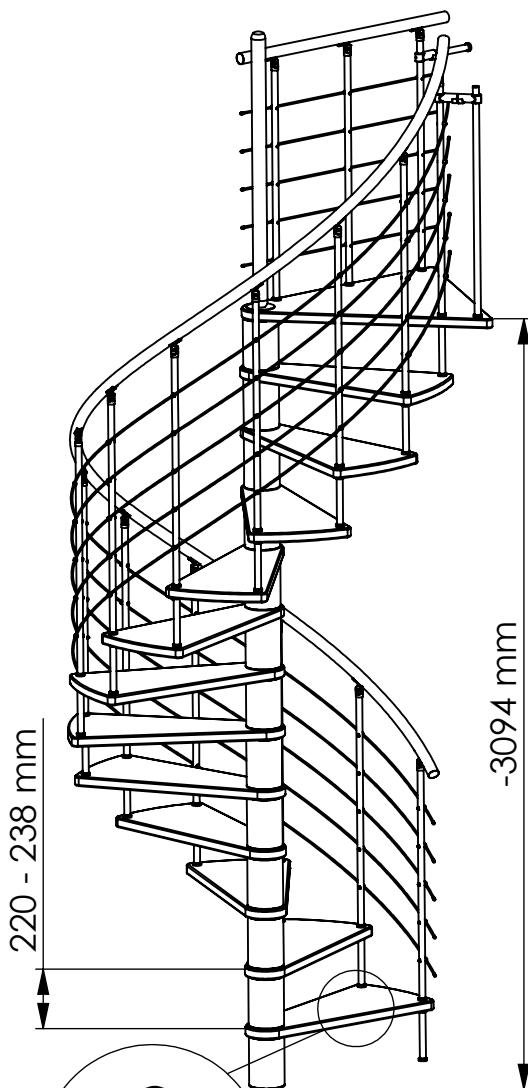

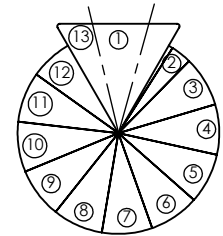
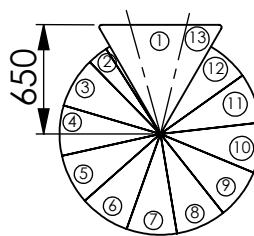

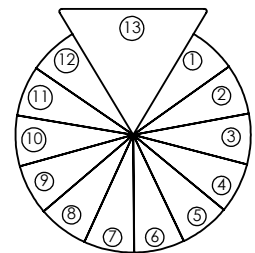
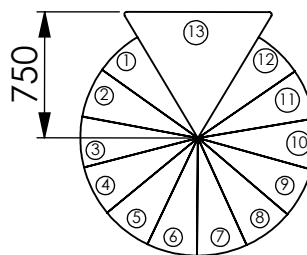



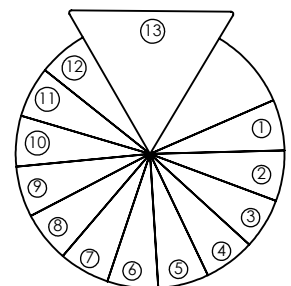
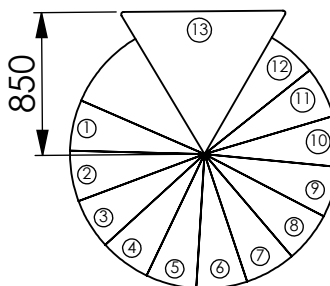

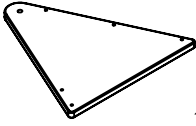
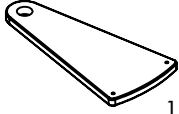
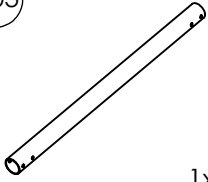

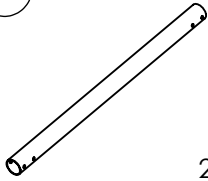
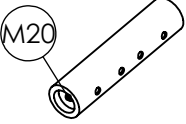
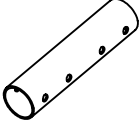
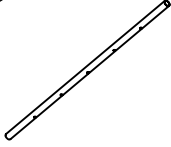
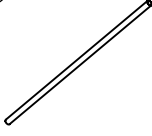
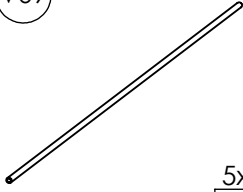
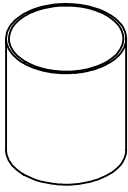
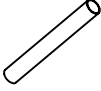

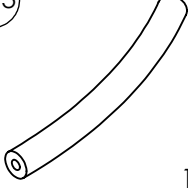
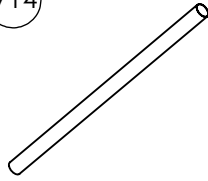
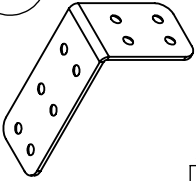
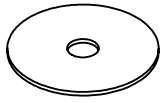
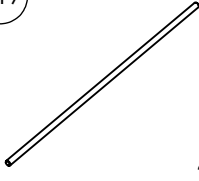

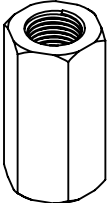

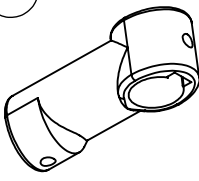
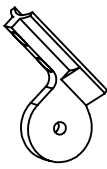

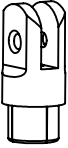







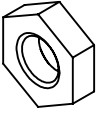
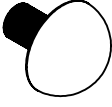

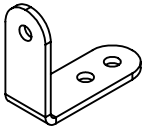

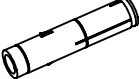
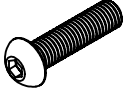
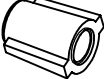
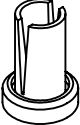
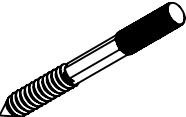

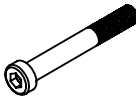

DM T40



DM T60

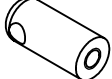

<p>V01</p>  <p>1x</p>	<p>V02</p>  <p>12x</p>	<p>V03</p>  <p>1x</p> <p>Ø 50 x 910x1 mm</p>	<p>V04a</p>  <p>1x</p> <p>Ø 51 x 100 mm</p>	<p>V05</p>  <p>2x</p> <p>Ø 60,2 x 980 mm</p>
<p>V06</p>  <p>M20</p> <p>1x</p> <p>Ø 51x2,6x220 mm</p>	<p>V07</p>  <p>1x</p> <p>Ø 51x2,6x220 mm</p>	<p>V08</p>  <p>16x</p> <p>Ø 22x1x840 mm</p>	<p>V08a</p>  <p>1x</p> <p>Ø 22x1x840 mm</p>	<p>V09</p>  <p>5x</p> <p>Ø 6x1x6000 mm</p>
<p>V10</p>  <p>13x</p> <p>Ø 127x179 mm</p>	<p>V11</p>  <p>14x</p> <p>Ø 22x1x175 mm</p>	<p>V12</p>  <p>1x</p> <p>Ø 22x1x70 mm</p>	<p>V13</p>  <p>12x</p> <p>Ø 40x400 mm</p>	<p>V14</p>  <p>1x</p> <p>Ø 40x950 mm</p>
<p>V15a</p>  <p>2x</p>	<p>V16</p>  <p>1x</p> <p>Ø 100 x 3 mm</p>	<p>V17</p>  <p>2x</p> <p>M20 x 1000 mm</p>	<p>V19</p>  <p>11x</p> <p>Ø 15x50 mm</p>	<p>V20</p>  <p>13x</p> <p>M10 x 120 mm</p>
<p>V21</p>  <p>1x</p> <p>M20 DIN 6334</p>	<p>V22</p>  <p>104x</p> <p>Ø 127 x 3 mm</p>	<p>V23</p>  <p>3x</p>	<p>V24</p>  <p>16x</p>	<p>V25</p>  <p>2x</p> <p>Ø 50 mm</p>
<p>V26</p>  <p>16x</p>	<p>V27a</p>  <p>12x</p> <p>Ø 8 mm</p>	<p>V27b</p>  <p>2x</p> <p>Ø 12 mm</p>	<p>V28</p>  <p>1x</p> <p>Ø 22 mm</p>	<p>V29</p>  <p>1x</p> <p>Ø 35 mm</p>

<p>V30</p>  <p>M20 DIN 934</p> <p>1x</p>	<p>V30a</p>  <p>M20 DIN 439B</p> <p>1x</p>	<p>V31</p>  <p>Ø 40 mm</p> <p>4x</p>	<p>V32</p>  <p>M5 DIN 934</p> <p>16x</p>	<p>V33</p>  <p>37x28x12 mm</p> <p>1x</p>
<p>V34</p>  <p>M6 DIN 562</p> <p>6x</p>	<p>V35</p>  <p>M8 x 55 mm</p> <p>4x</p>	<p>V36</p>  <p>M10 x 70 mm</p> <p>16x</p>	<p>V37</p>  <p>M10</p> <p>44x</p>	<p>V38</p>  <p>44x</p>
<p>V39</p>  <p>M10 x 100 mm</p> <p>2x</p>	<p>V40a</p>  <p>M8 x 50 mm</p> <p>4x</p>	<p>V41</p>  <p>M8x55mm DIN6912</p> <p>8x</p>	<p>V42</p>  <p>M5 x 20 mm DIN7991</p> <p>16x</p>	<p>V43</p>  <p>M6 x 6 mm DIN 914</p> <p>6x</p>
<p>V44</p>  <p>Ø 6 x 50 mm</p> <p>12x</p>	<p>V45</p>  <p>Ø 6 x 30 mm</p> <p>8x</p>	<p>V46</p>  <p>Ø 3,9 x 19 mm</p> <p>2x</p>	<p>V47</p>  <p>Ø 30 x 3 mm</p> <p>84x</p>	<p>V49</p>  <p>8x</p>
<p>V50</p>  <p>Ø 3,5 x 25 mm</p> <p>59x</p>	<p>V51</p>  <p>80x</p>	<p>V52</p>  <p>M6 x 14 mm</p> <p>80x</p>	<p>V53</p>  <p>Ø 8 x 12 mm</p> <p>20x</p>	<p>V54</p>  <p>Ø 4 x 25 mm</p> <p>16x</p>

h	
0xV47	= 220 mm
1xV47	= 223 mm
2xV47	= 226 mm
3xV47	= 229 mm
4xV47	= 232 mm
5xV47	= 235 mm
6xV47	= 238 mm

h	
2xV22	= 220 mm
3xV22	= 223 mm
4xV22	= 226 mm
5xV22	= 229 mm
6xV22	= 232 mm
7xV22	= 235 mm
8xV22	= 238 mm

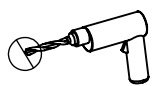
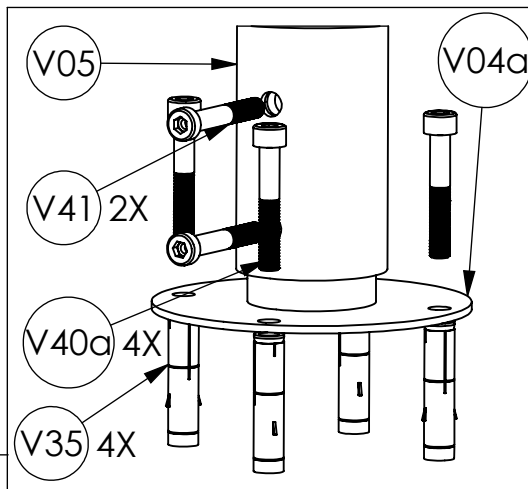
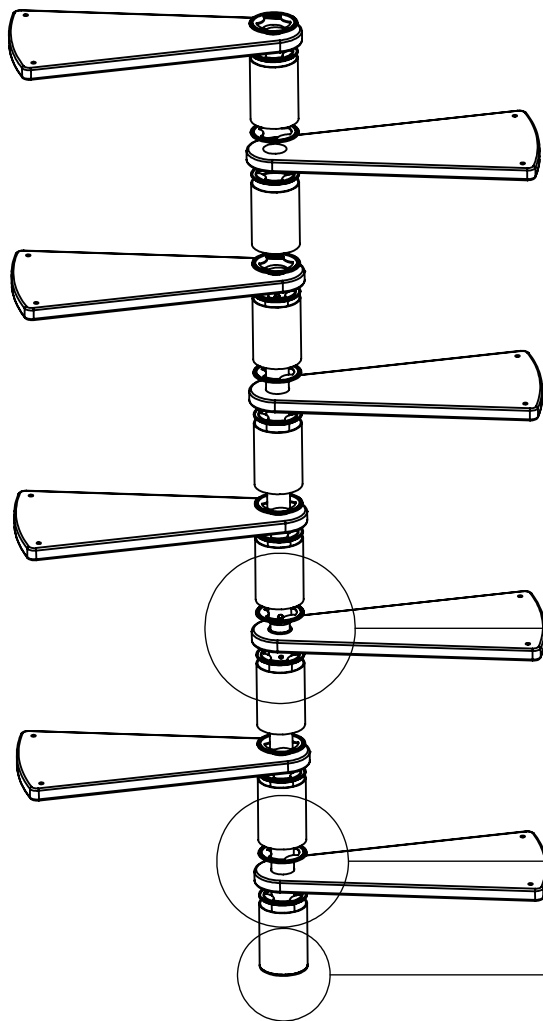
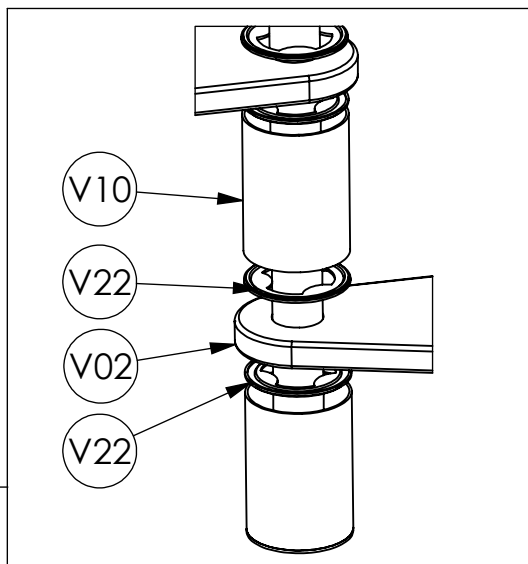
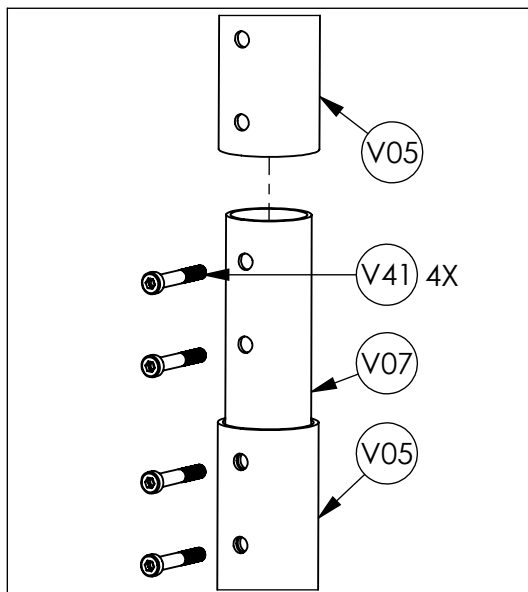

12 mm

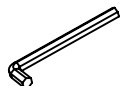

6 mm

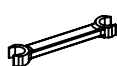

13 mm

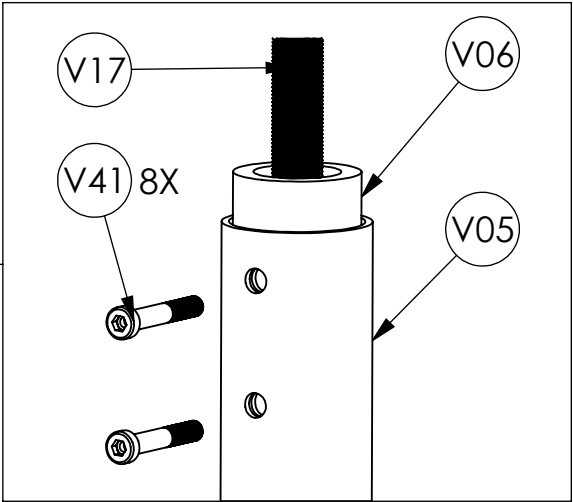
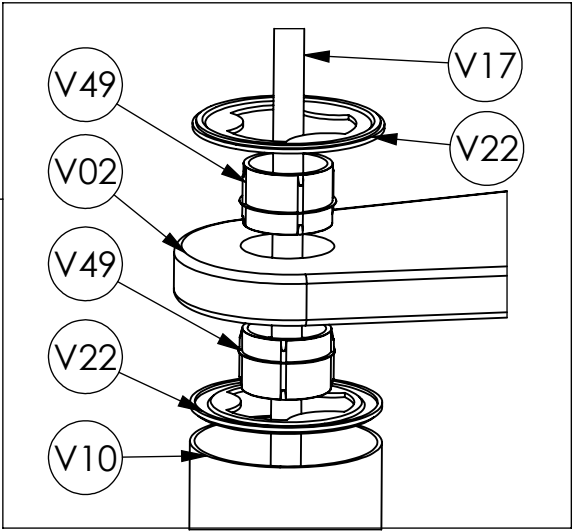
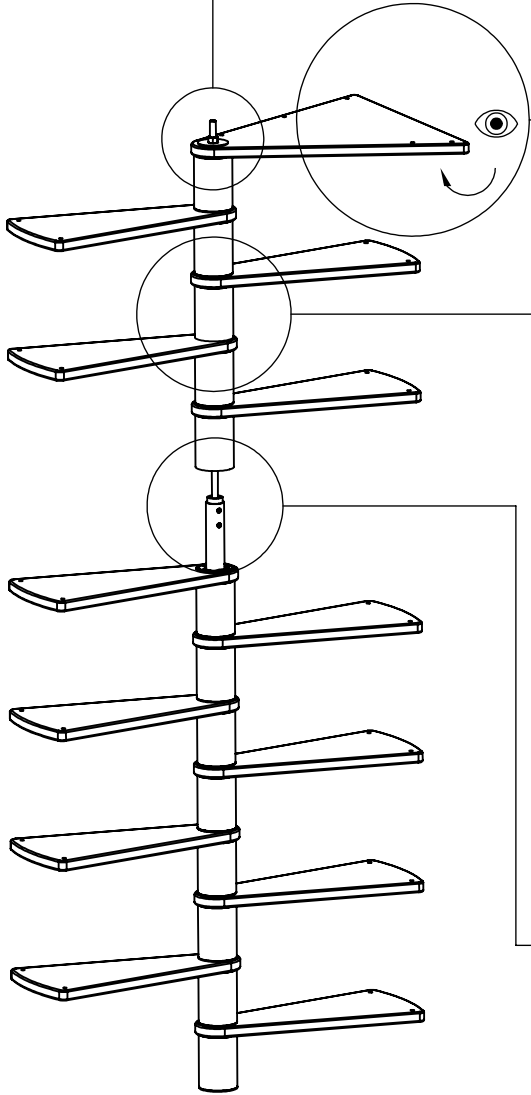
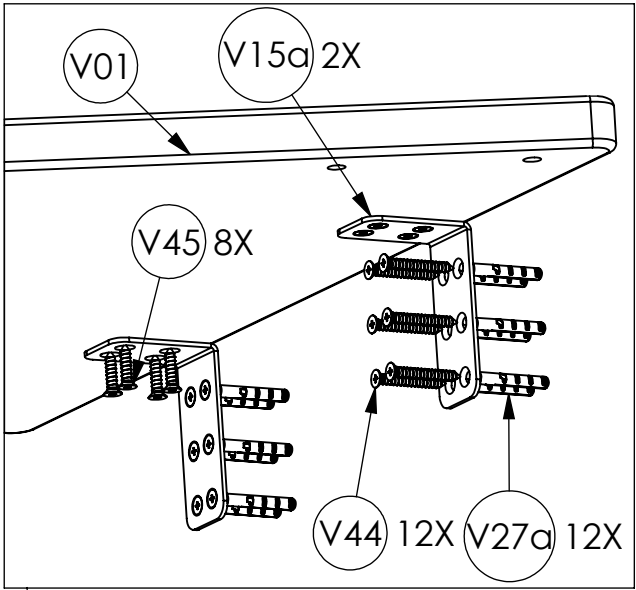
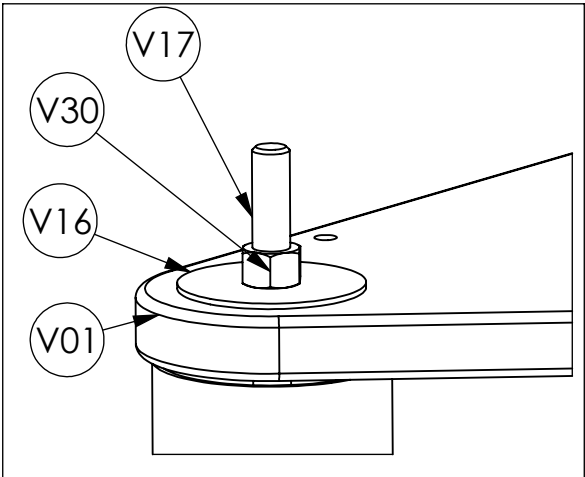

5



30 mm

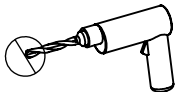

8 mm



6 mm

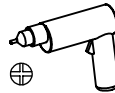

+

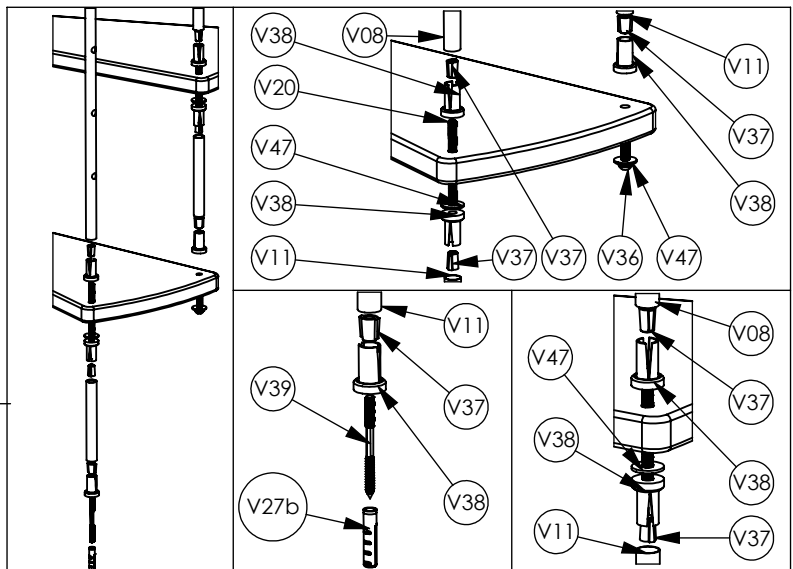
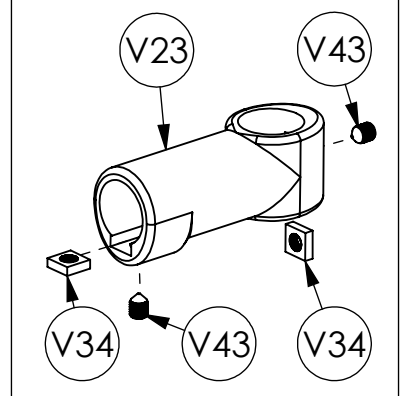
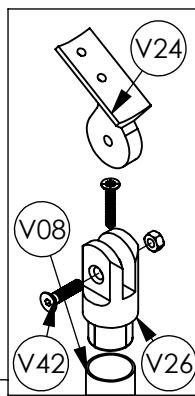
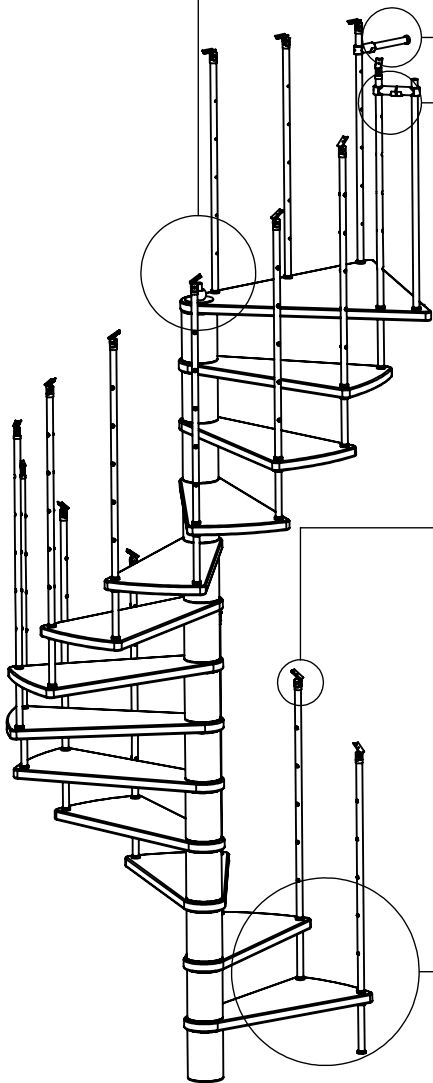
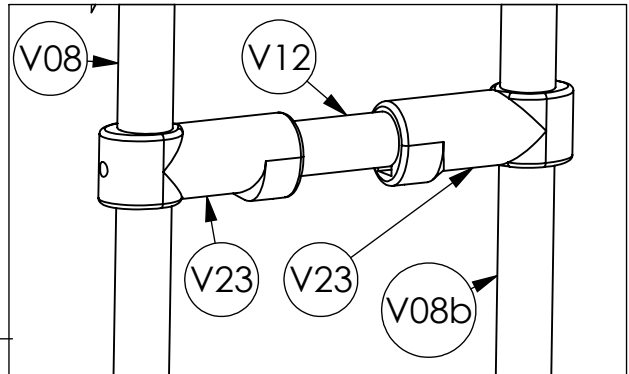
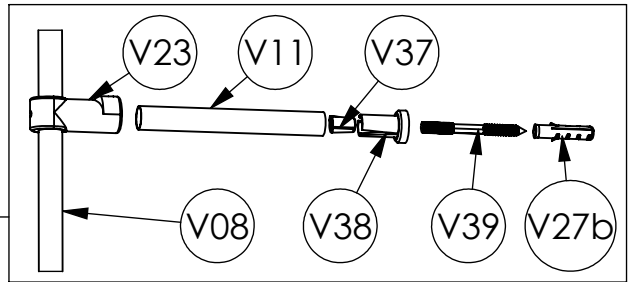
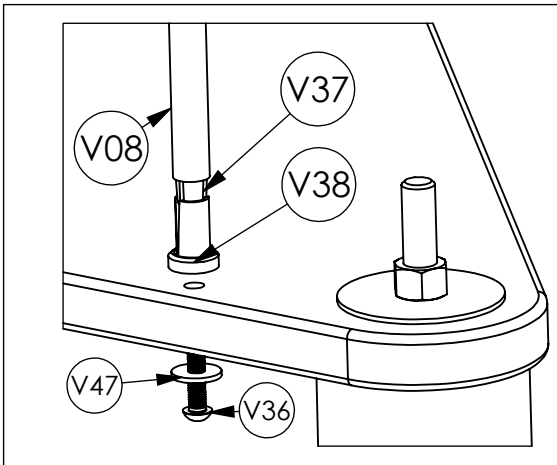

6

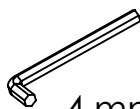

4 mm



3 mm

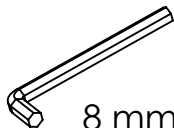

8 mm

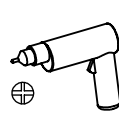

12 mm

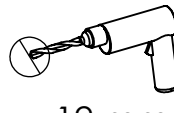

8 mm

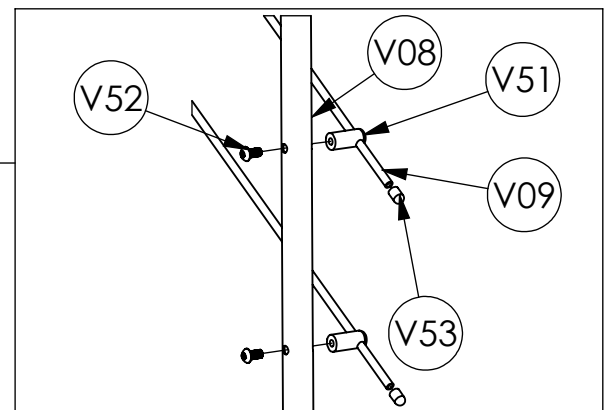
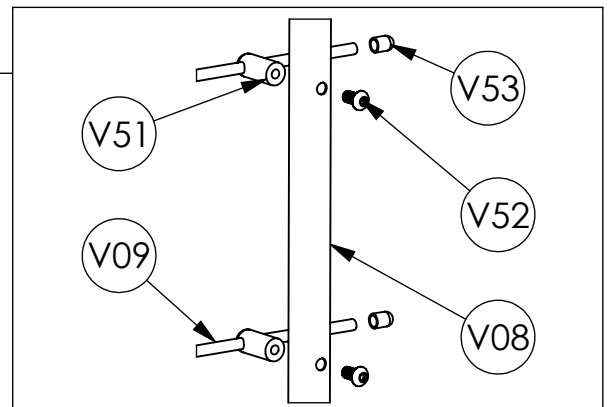
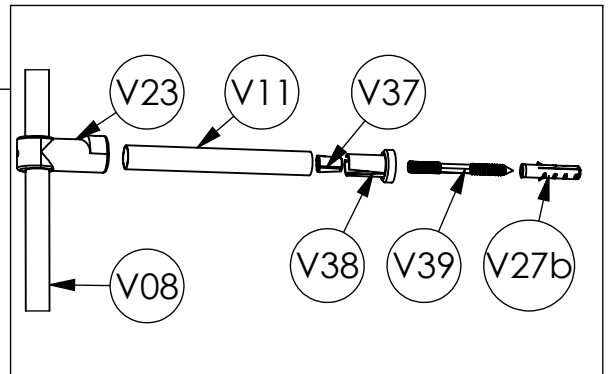
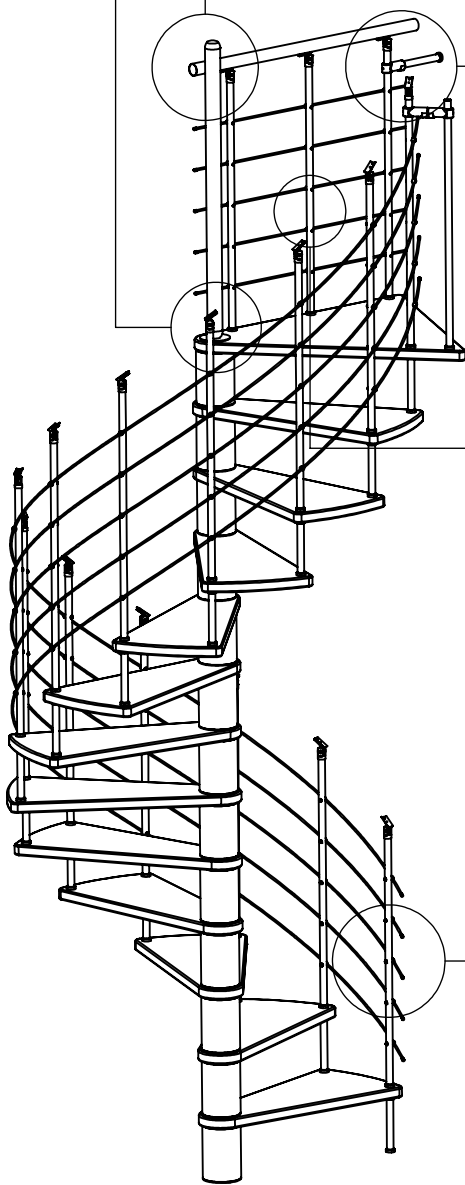
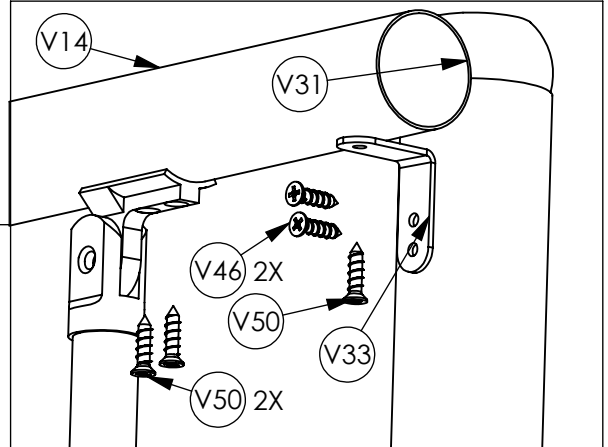
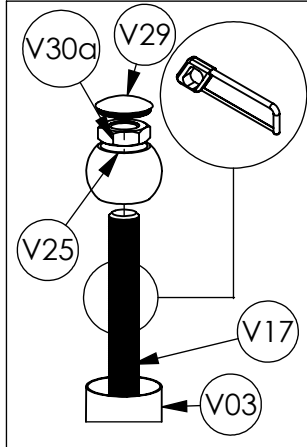
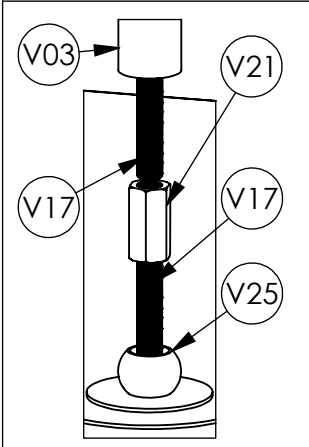

7

