

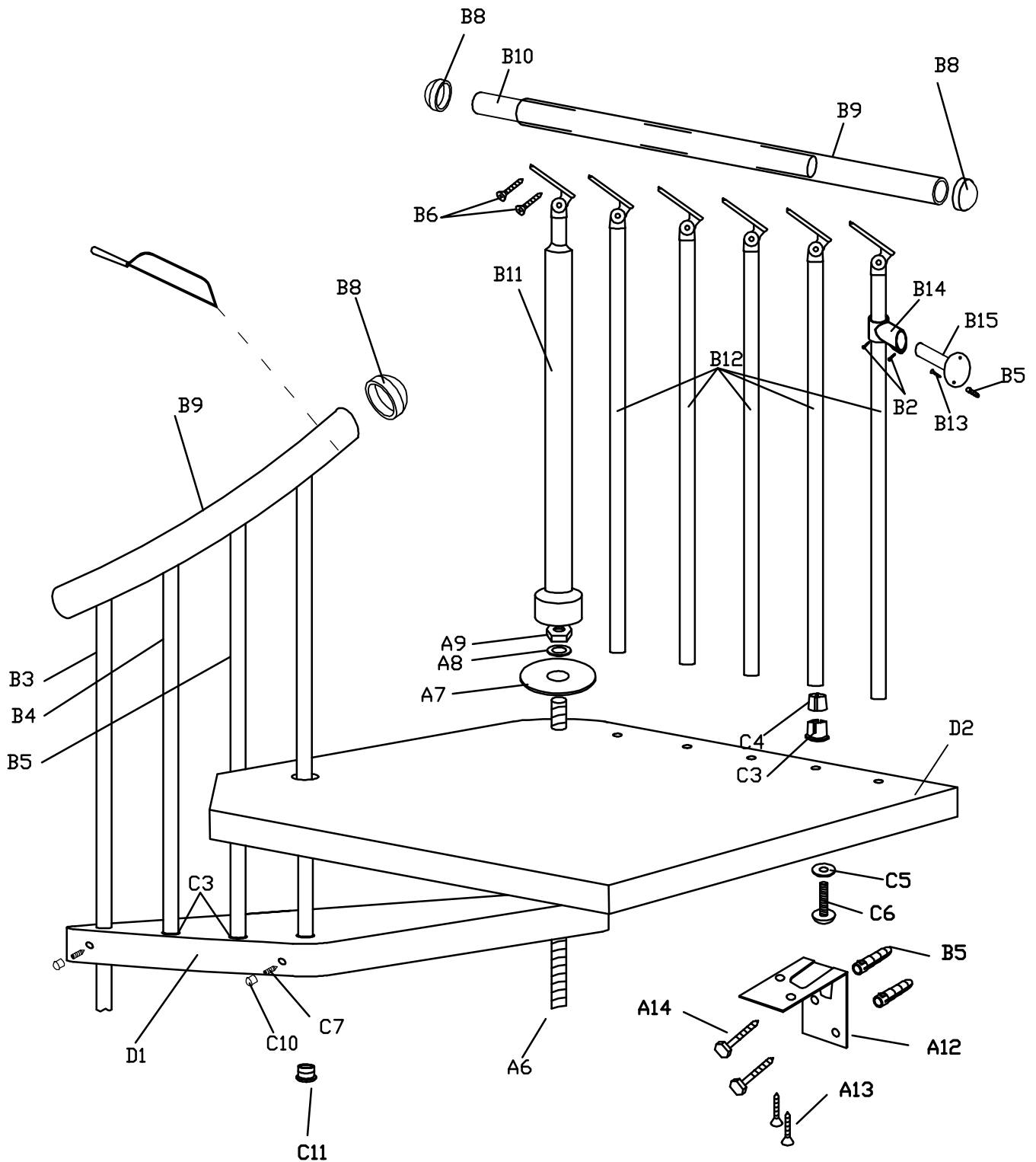

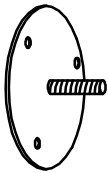







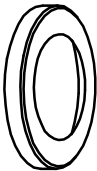
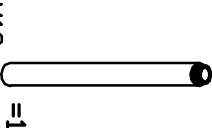
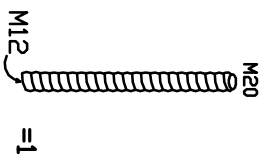



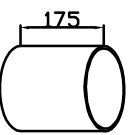
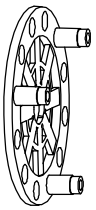
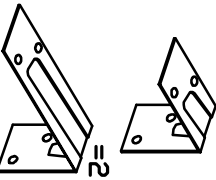

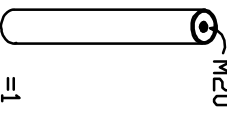

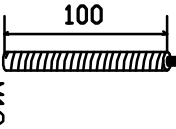

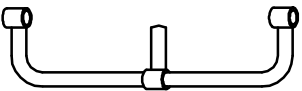

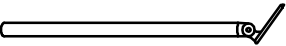
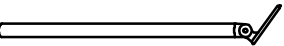

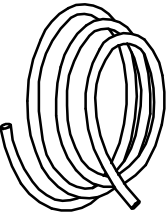

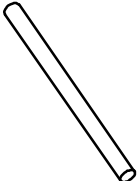
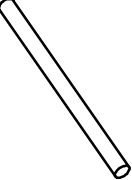
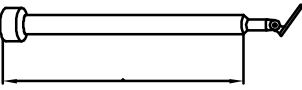
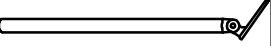





**FLAMENCO G - D 120/140/160**



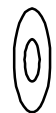

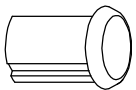



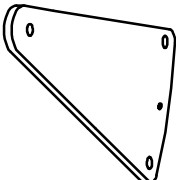
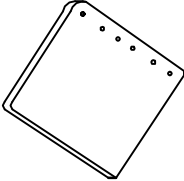

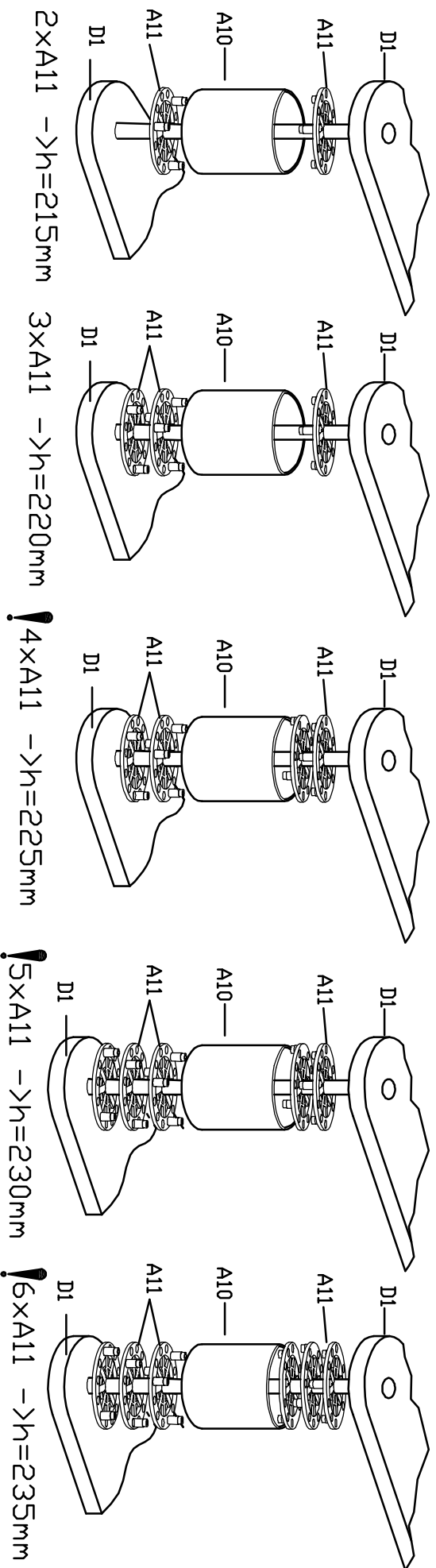

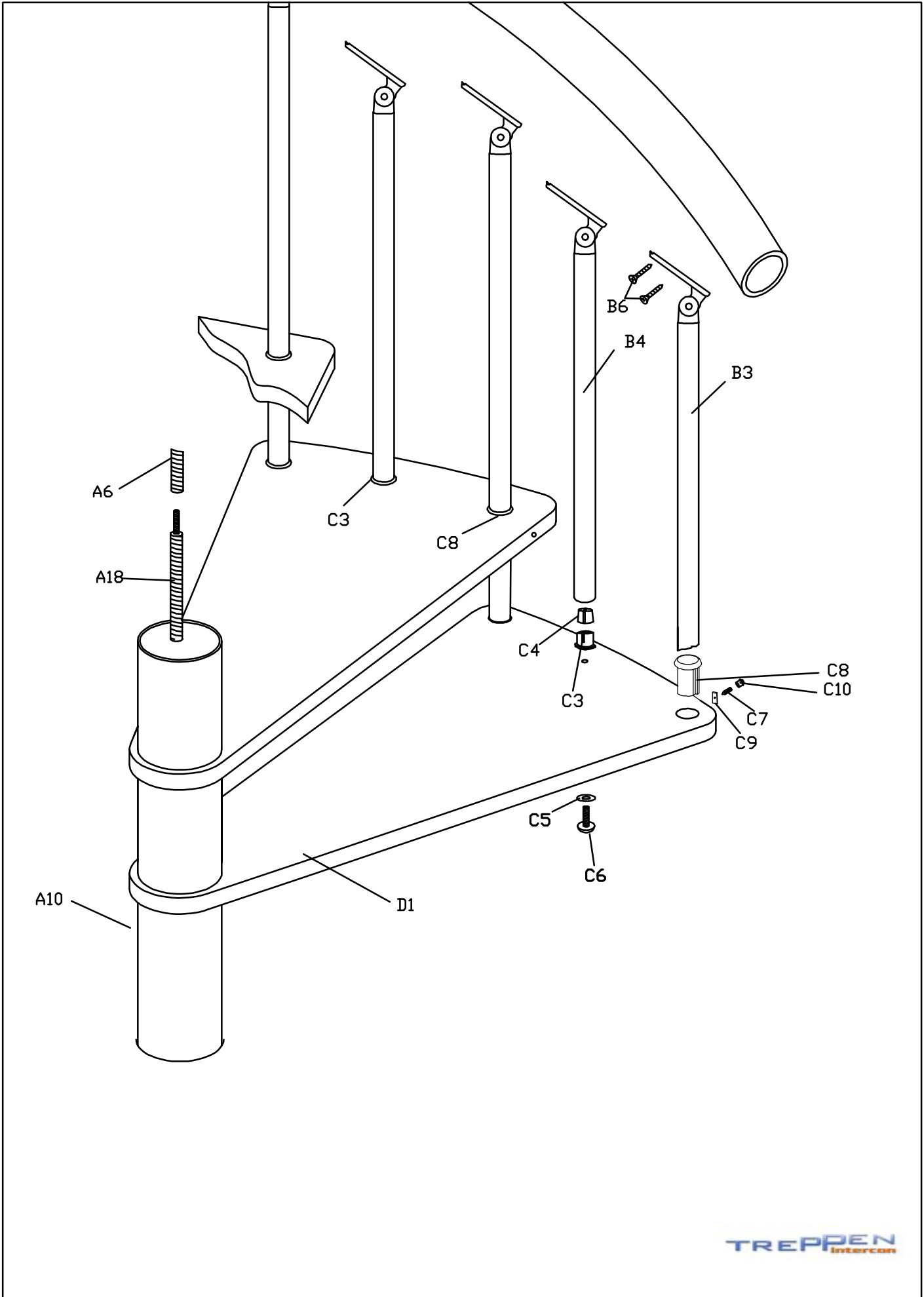

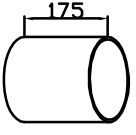
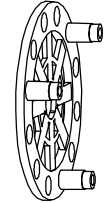
**Um den Handlauf montieren zu können, muss die Zimmertemperatur über 16 Grad betragen**

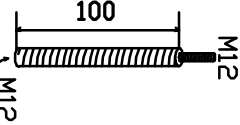
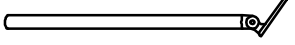
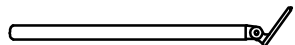
A1		=1	
A2	 12 mm	Ø12	=3
A3	 Ø8x80	Ø8x80	=3
A4			=1
A5	 M12	M12	=1
A6	 M20	M20	=1
A7			=1
A8	 A20	A20	=1
A9	 M20	M20	=2
A10	 175		=13
A11			=78
A12			=2
A13	 5x25	5x25	=12
A14	 Ø6x80	Ø6x80	=8
A16	 M20	M20	=1
A17			=7
A18	 M12	M12	=1
A19			=1
B1			=1
B2	 3,5x12mm	3,5x12mm	=7
B3	 1155 mm	1155 mm	=13
B4	 1010 mm	1010 mm	=12
B5	 Ø10	Ø10	=12
B6	 4X16	4X16	=66
B7			=1
B8			=4
B9			=1
B10			=1
B11	 955	955	=1
B12	 955 mm	955 mm	D120 D140 D160 =5 =6 =7
B13	 5x50	5x50	=2
B14			=2
B15			=1

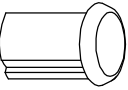
C1	 12 mm Ø12 =1	C2	 M8x80 =1	C3	 =20	C4	 =20	C5	 8 mm A8x24 =19	C6	 M8x60mm =19	C7	 M6x6 =25 HEX 3=1	C8	 =25	C9	 =25
C10	 =25	C11	 =12									D1	 =12	D2	 =1		



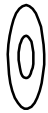
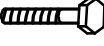
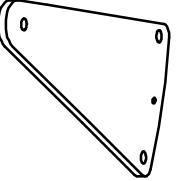

<p>A10</p>  <p>175</p> <p>=1</p>	<p>A11</p>  <p>=6</p>	<p>A17</p>  <p>=2</p>	<p>A18</p> <p>M12</p>  <p>100</p> <p>M12</p> <p>=1</p>	<p>B3</p> <p>1155 mm</p>  <p>=1</p>	<p>B4</p> <p>1010 mm</p>  <p>=1</p>	<p>B6</p> <p>4X16</p>  <p>=2</p>		<p>C7</p> <p>M6x6 =2</p> <p>HEX 3=1</p> 	<p>C8</p>  <p>=2</p>	<p>C9</p>  <p>=2</p>	<p>C10</p>  <p>=2</p>	<p>C11</p>  <p>=1</p>
<p>C3</p>  <p>=1</p>	<p>C4</p>  <p>=1</p>	<p>C5</p> <p>8 mm</p> <p>A8x24</p>  <p>=1</p>	<p>C6</p> <p>M8x60mm</p>  <p>=1</p>	<p>D1</p>  <p>=1</p>								